



TIMRA



VISTA

open flue built-in fireplaces

installation guide and user manual

“ Log Burner technology”

faber

Saturnus 8 NL-8448 CC Heerenveen

Postbus 219 NL-8440 AE Heerenveen

T. +31(0)513 656500

F. +31(0)513 656501



faber

CONTENTS

CONTENTS.....	5
1. INTRODUCTION.....	6
2. SAFETY AND GENERAL INFORMATION.....	7
2.1 General safety.....	7
3. INSTALLATION REQUIREMENTS.....	9
3.1 Builders opening and surround.....	9
3.2 Flue requirements.....	12
4. INSTRUCTIONS FOR INSTALLATION.....	14
4.1 Gas connection.....	14
4.2 Preparing the appliance.....	15
4.3 Fitting the firebox.....	16
4.4 Placing the log set.....	20
5. REMOTE CONTROL.....	21
5.1 Remote control (if applicable).....	21
5.2 Installation remote control.....	22
6. COMMISSIONING (FUNCTIONAL CHECKS).....	24
6.1. Check pilot ignition.....	24
6.2 Functional burner check.....	24
6.3 Spillage test.....	25
6.4 Flame Supervision & Blocked Flue Monitoring System.....	26
6.5 Check setting pressure.....	26
7. HANDING OVER (FINAL CHECK AND CUSTOMER BRIEFING).....	27
8. SERVICING.....	28
8.1 Routine annual servicing.....	28
USER GUIDE	34
9. SAFETY INSTRUCTIONS FOR THE USER.....	35
9.1 General safety instructions.....	35
10. CONTROLLING THE APPLIANCE.....	37
10.1 Lighting the fire.....	37
10.2 To light.....	39
10.3 To extinguish.....	39
10.4 Remote control version.....	40
11. CLEANING AND SERVICE INSTRUCTIONS.....	44
12. DISPOSAL OF PACKAGING AND APPLIANCE.....	45

1. INTRODUCTION

Note: these instructions should be read carefully and retained for future reference.
Please leave these instructions with the user.

This guide is concerning the following types of appliances:

TIMRA: for installation in a surround

VISTA: for installation as a hole in the wall

Special features:

- Realistic flame and glow effect.
- Small flue outlet, 100 mm.
- Remote Control option on all appliances.
- A spillage monitoring system (TTB switch) is fitted which cuts off the gas, if flue is blocked or malfunctioning.
- Meets the essential requirements of the European Gas Appliance Directive (GAD) and carries the CE mark.

2. SAFETY AND GENERAL INFORMATION

Before installation, ensure that the local distribution conditions (Identification of the type gas and pressure) and the adjustment of the appliance is compatible.

This gas appliance is factory set and shall not be adjusted by the installer .

The spillage monitoring system must not be put out of operation.

This appliance does not contain any component manufactured from asbestos or any asbestos related products.

2.1 General safety

It is the law in the UK that all gas appliances, are installed by a competent person in accordance with the Gas Safety (Installation and Use) Regulations (As amended), the relevant British Standards for Installation work, Building Regulations, Codes of Practice and the manufacturer's instructions.

The installation should also be carried out in accordance with the following where relevant:

BS8303	BS5871 Part1
BS5440 Parts 1&2	BS715
BS6891	BS1251

Building Regulations Document J (as applicable).

Building Regulations and Standards issued as relevant by the Department of the Environment or the Scottish Development Department.

In the Republic of Ireland installation should be carried out in accordance with IS813, ICP3, IS327, Building Regulations, Codes of Practice, the manufacturer's instructions and any other rules in force.

Failure to comply with the above could leave the installer liable to prosecution and invalidate the appliance warranty.

The appliance must not be installed in a room containing a bath or shower or where steam may be present.

Ventilation

No purpose provided ventilation is normally required when this appliance is installed in the UK. Where other appliances operate in the same room or space then these should be considered when sizing air vents. The spillage test in the section commissioning may indicate that purpose provided ventilation is required. Where fitted ventilation must comply with BS5440 part 2. For the Republic of Ireland the ventilation requirements may vary and if unsure then advice should be sought from the relevant authorities.

Safety instructions for the user: see chapter 9.

3. INSTALLATION REQUIREMENTS

Note:

Since the appliance is a source of heat, circulation of air occurs. Therefore it is of importance that you do not use the appliance shortly after a renovation of the home.

Because of the natural circulation of air, moist and volatile components from paint, building materials, carpet etc. will be attracted. These components can settle themselves down onto cold surfaces in the form of soot.

As on all heat producing appliances, soft furnishings such as blown vinyl wallpaper placed too near to the appliance may become scorched or discoloured. This should be born in mind when installing the appliance.

3.1 Builders opening and surround

The appliance can be installed in the following situations:

In a non-combustible fireplace or builders opening. This could be either an existing builders opening or a new made prefab builders opening. For the measurements, see figure 1 and index.

Although the appliance is tested for installation without a hearth, the appliance must not stand on combustible materials or carpets. If the appliance is placed on a combustible floor then a fibrelux or similar heatproof board of 12 mm thickness should be placed under it. Any under floor vents or openings within the builders opening should be sealed off.

Do not place the lintel, surround or marble stone directly onto the appliance. If possible, apply a lintel made of cement or something similar.

3.1 Builders opening and surround (continuing)

If the builders' opening is constructed of anything other than brick e.g. stud work and rendered plaster then:

- Ventilate the space above the appliance (min. 1000 mm²).
- The plaster of the outside has to be resistant to a high temperature. Use therefore the plaster materials especially made for this such as Masterboard or Fibrelux, to prevent discolouring (min. 100 degrees temperature resistant).

If the appliance is to be fitted against a wall with combustible cladding, the cladding must be removed from the area covered by the surround.

The minimum height from the top surface of the fire to the underside of any shelf made from wood or other combustible materials is as follows:

- For a shelf up to 150 mm deep – Minimum height = 350 mm (fig. 1).
- If the shelf depth is greater than 150 mm add 50 mm to the shelf clearance height for every 25 mm increase in shelf depth.
- Side clearance = Minimum distance from the side of the fire frame to combustible material = 150 mm.

MEASUREMENTS BUILT IN AND APPLIANCE

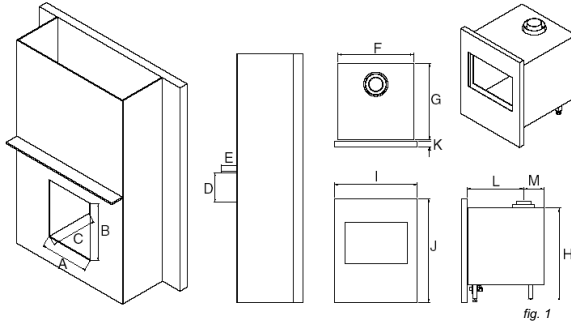

fig. 1

	Builders opening (mm)	Timra	Vista
A	Opening width	420	450
B	Opening Height	565	590
C	Opening Depth (min.)	370	370
	Shelf dimensions (combustible)		
D	Minimum height shelf from top frame	350	350
E	Depth shelf	150	150
	Dimensions (mm)		
F	Box width	410	410
G	Box Depth	318	318
H	Box height	557	557
I	Frame width	440	490
J	Frame height	576	626
K	Frame Thickness	10	20
L	Position flue (behind frame)	228	238
M	Position flue (from the back side box)	90	90

3.2 Flue requirements

Suitable flues and flue sizes are as follows:

- flexible stainless-steel liner or pipe (to BS715). The flue connector outer collar is for connection to a 125 mm (5 inch) internal diameter pipe or liner. The inner collar is for connection to a 100 mm internal diameter pipe or liner.
- min. 100 - max. 150 mm factory made insulated flue manufactured to BS 4543.
- max. 225 mm x 255 mm conventional brick flue.
- min. 100 mm - max 175 mm diameter lined brick or stone flue.

The flue, most have a positive up draught.

The minimum effective height of the flue system must be 3 meter.

The flue must not be used for any other appliance or application.

Any chimney damper or restrictor should be removed. If removal is not possible, they must be secured in the fully open position.

The appliance is intended to be installed to a chimney which was previously used for solid fuel, the flue must be swept clean prior to installation. All flues should be inspected for soundness and freedom from blockages.

When installing a flexible flue liner, it must be fully contained within another flue and properly supported.

3.2.1 Terminal locations

Site in accordance with BS 5440-1:2000 and the document J

Flue terminal positions for pitched roofs

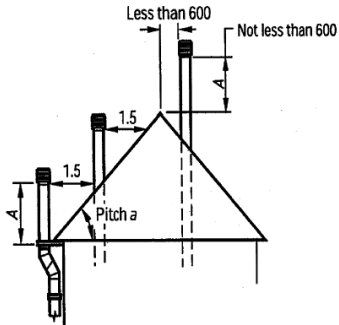

No part of the flue outlet shall be less than 1.5 m measured horizontally to the roof surface, or 600 mm above the ridge.

a) Terminal locations with respect to pitch

fig. 2

4. INSTRUCTIONS FOR INSTALLATION

4.1 Gas connection

1. Installation pipes should be in accordance with BS 6891. Pipe work from the meter to the appliance must be of adequate size.
2. The complete installation including the meter must be tested for soundness and purged as described in the above code.
3. A means of isolation must be provided in the supply to facilitate servicing.
4. The connection should be made in 8 mm copper or similar semi flexible tube (max. 1 meter). Ensure that the gas pipe does not interfere with the removal or replacement of the burner tray of the controls.
5. The supply gas feed line should enter the appliance through one of the openings in the appliance case. Openings are at the back and right side.
6. The gas connection is nut and olive suitable for 8 mm pipe.
7. Where a gas pipe passes through a void, wall or cavity it must be fully enclosed in a sleeve.

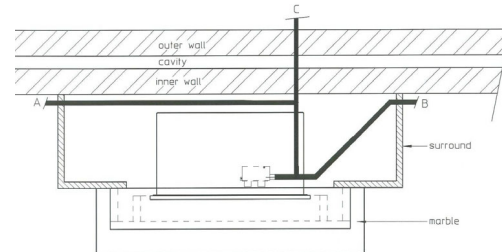

Gas supply routes when fire is fitted in a deep surround

A & B = Behind surround – Sleeve pipe through surround

C = Through wall – Pipe must be sleeved and sealed to fire

4.2 Preparing the appliance

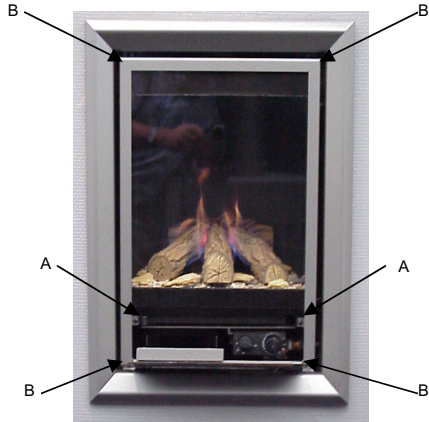

1. Open the ashtray door and remove the two screws A.
2. Lift and remove the glass frame.
3. Remove the trim by unscrewing the four screws B.
4. Take the box with the log set out of the combustion chamber.

4.2 Preparing the appliance (continuing)

5. Disconnect the TTB cable.

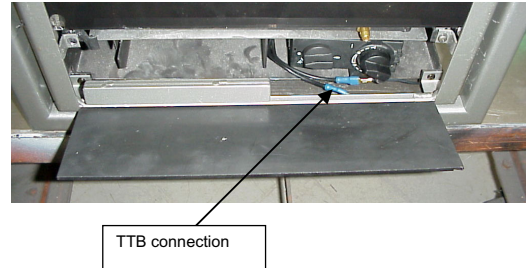

6. Remove the burner chamber out of the firebox.

4.3 Fitting the firebox

1. Position the firebox in the fireplace opening.
2. If the appliance is placed on a combustible floor then a fibrelux or similar heatproof board of 12 mm thickness should be placed under it.
Any under floor vents or openings within the builders opening should be sealed off.

4.3 Fitting the firebox (continuing)

3. The surface of the floor must be sufficiently flat to enable the bottom of the front surround and door to be aligned horizontally.
4. The front face of the fireplace should be reasonably flat over the area covered by the firebox to ensure good sealing.
5. Make the gas connection according to the instructions (also see gas connection, chapter 4.1).
6. Secure the vent connector unit to the flue pipe or chimney liner.

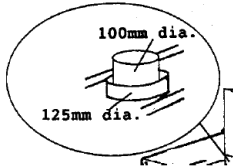

The flue connector outer collar is for connection to a 125 mm (5 inch) internal diameter pipe or liner. The inner collar is for connection to a 100 mm internal pipe or liner (see fig.)

4.3 Fitting the firebox (continuing)

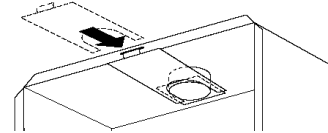

7. Slide the clamping plate with the lip upward under the vent connector. The flue connector and pipe or liner rests on the clamping plate. Make sure that the lip of the clamping plate goes in the slot on the front of the firebox (see fig.).
8. Slide the burner chamber into the firebox.
9. Pull the clamping plate out. The flue collar plate makes contact with the burner chamber.

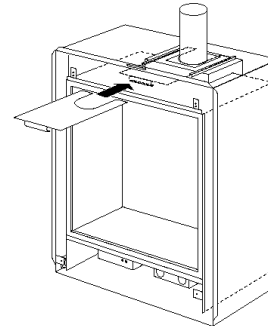

4.3 Fitting the firebox (continuing)

10. Turn the clamping plate up side down and slide the plate between the guides so that its ends grip around the pipe opening (see last figure previous page). Make sure that the flue collar plate is pressed onto the burner chamber.
11. Locate the log set (see placing log set, chapter 4.4).
12. Spread the bags of embers (3 different types of imitation ashes) provided with the appliance over the burner tray.
Note: there is no glow effect from the embers.
13. Place the trim.
14. Before placing the glass frame; check the glass sealing rope is in good condition. Be sure that there are no fingerprints on the glass. It is not possible to remove those prints after you burn the appliance for a while (they are burnt in). Place the glass in front of the appliance and fix the glass frame.

4.4 Placing the log set

Never place extra elements of any kind into the combustion chamber. To guarantee good combustion, the log set may only be installed in the way specified by Faber International. Any other arrangement can lead to soot on logs or window. Do not use the fire with broken or missing logs.



The log set consists of a rear log and 3 logs to cover the burners.
Place the rear log into the U section in the back of the combustion chamber.

On the bottom of the logs is an identification:

- 1 dimple first log left placed over the burner and resting on the burner tray.
 - 2 dimples placed in the middle over the burner and resting on the burner tray.
 - 3 dimples the right side log placed over the burner and resting on the burner tray.
- You are allowed to add different kind of embers on the burner tray to create your own ash bed.

Note: be sure that there are no embers between the log burners and the burner tray.

The logs on the burners have to stand on the burner tray.

5. REMOTE CONTROL

5.1 Remote control (if applicable)

The remote control is only meant to regulate the flames, it functions only when the pilot burner is ignited. It is therefore not possible to ignite the appliance with the remote control or to shut-off the pilot flame.

The radio-frequency remote control is intended for fireplaces installed in a domestic setting in all EU countries, except Austria, Denmark, Finland and Greece.

Features:

- Manual control will always remain possible.
- The remote control is a radio frequency type and has been approved internationally.
- The remote control generates a unique safety code every time you activate the transmitter, it's similar to those used in a car.
- The remote control is easy to install retrospectively.

5.2 Installation remote control

1. Connect the transformer to the receiver box.

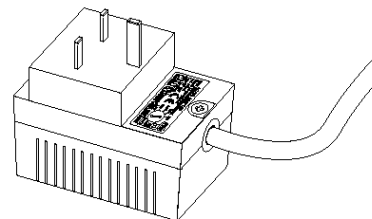

2. Slide the receiver box into the holder.

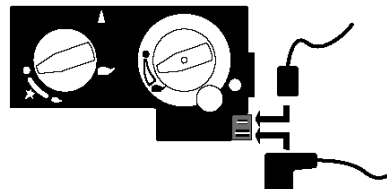

3. Connect the wires to the gas valve.
4. Check that there are batteries in the transmitter. See "Replacing batteries".
5. Set the on/off switch on the receiver to "on".

5.3 Installation remote control (continuing)



Setting the right transmission code

The receiver has to learn the code from the transmitter, which is already set at the factory. However the code disappears if the receiver is disconnected from the mains for a longer period.

1. Push the "mod" button on the receiver and hold it for 3 seconds.
2. The green control lamp will light up and stay on. Repeat this step if not.
3. Push a button on the remote control. The control lamp on the receiver should now go out.
4. Again push a button on the remote control. The lamp starts flashing and will switch off eventually.
5. The receiver now recognizes the remote control. The remote control now functions.
6. Check if you can hear a sound and the motor runs when you push a button on the remote control.

6. COMMISSIONING (functional checks)

6.1. Check pilot ignition

1. Push in and turn the control knob (A) anticlockwise to the setting  (small flame). You will hear a tick meaning there is ignition. Hold the knob in and wait for a few seconds while the air is purged.
2. Bring the knob back in the start position and turn the knob several times to the  position. Check that the pilot has lit.
3. Continue to hold in the control knob for a further ten seconds to ensure that the pilot flame is stable.
4. Release the knob. The pilot should remain alight.

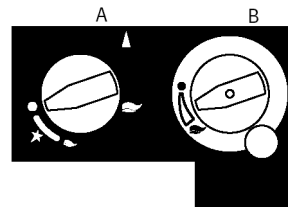

6.2 Functional burner check

1. Turn knob (B) to max. clockwise.
2. Turn the knob (A) more anticlockwise to the position  (large flame). Now it is possible to light the main burner.
3. Turn knob B anticlockwise to max. The main burner should light.

6.2 Functional burner check (continuing)

4. Check the ignition of the main burner on low and high setting.
5. Turn knob B clockwise till ●. The main burner is off.
6. Turn the knob A to ●. The pilot should go out.

6.3 Spillage test

1. Carry out the lighting procedure and turn the fire to high.
2. Allow to warm up for 15 minutes and then using a smoke match with holder set 100% inside the square tube on the top of the appliance between the trim and the glass frame. The installation is satisfactory if most of the smoke is drawn into the tube.
3. Repeat the test with doors and windows to the premises open and closed, and with any extractor fans in the same room or adjacent rooms running on high.
4. Check that any other open flued appliances and their flues in the same or adjoining rooms functions correctly when this appliance is alight.



6.4 Flame Supervision & Blocked Flue Monitoring System

The pilot unit incorporates a system, which will shut off the gas supply if the flue is faulty. If the flue is faulty, the hot flue gasses will pass over and actuate a heat sensitive switch, which will shut off the gas supply.

This monitoring system (TTB) must not be adjusted, bypassed or put out of operation. This TTB, or any of its parts, must only be exchanged using Faber International authorised parts.

6.5 Check setting pressure

The appliance is preset to give the correct heat input. No further adjustment is necessary. Fit a pressure gauge at the test point to check the working pressure.

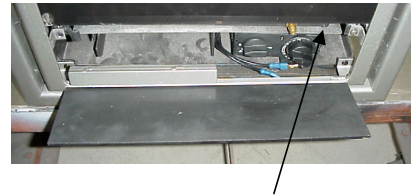

Fit a pressure gauge at the **test point** to check the setting pressure. The pressure should be checked with the appliance alight and at max. input. If the setting pressure is not correct then check the working pressure. After checking the pressure, turn off the appliance. Remove the pressure gauge and close the sealing screw. Re-light the appliance. Turn to max. input and test around the test point D for gas soundness using a suitable leak detection fluid.

7. HANDING OVER

(final check and customer briefing)

- 7.1 Instruct the customer on the full operation of the appliance.
- 7.2.1 Advise the customer how to clean the appliance including the glass.
- 7.2.2 Instruct the customer on the operation of the remote control, including replacement of batteries and how to set the right transmissions code.
- 7.2.3 Hand over these instructions including the user guide to the consumer.
- 7.2.4 Recommend that the appliance should be serviced by a competent person at least once a year.

8. SERVICING

To ensure safety, efficient operation of the appliance, it is necessary to carry out routine servicing at regular intervals.

It is recommended, that the fire is inspected/serviced by a competent person at least once a year.

Important:

Turn off the gas supply before commencing any servicing. Always test for gas soundness after refitting the appliance .

8.1 Routine annual servicing

1. Clean (if necessary):
 - the pilot system;
 - the burner;
 - the combustion chamber;
 - the glass.
2. Check the log lay and replace the embers (if applicable).
3. Do the functional test as described at 6.2.
4. Check the flue system and do a spillage test as described at 6.3.

Note

Never place extra elements of any kind into the combustion chamber.

To guarantee good combustion, the log set may only be installed in the way specified by Faber International. Any other arrangement can lead to soot on logs or window. Do not use the fire with broken or missing logs.

8.1.1 Cleaning the glass

Depending on the intensity of use, you can get a deposit on the glass. This can be removed with a special non abrasive ceramic glass cleaner (ceramic cook-top cleaner) as follows:

1. Remove the glass frame as described at 4.2.
2. Clean the glass. Handle the glass with clean hands, wear gloves if possible.
3. To fit the glass, proceed in reverse order. Make sure that the log set has been installed correctly before fixing the glass.

Attention:

Before placing the glass: check the glass sealing rope is in good condition. Be sure that there are no fingerprints on the glass. It is not possible to remove those prints after you burn the appliance for a while (they are burnt in).

8.1.2 Cleaning the combustion chamber and burner

You can clean the combustion chamber with a vacuum cleaner.

8.1.3 Propane conversion

For conversion from natural gas to propane, order for a propane burner unit
Please give the serial number from the data badge when you order

8.1.3 Burner tray assembly log burner

1. Remove the glass frame, trim, log set and burner tray cover.
2. Break the gas supply at the control valve.
3. Unscrew the burner assembly and take them out of the combustion chamber.

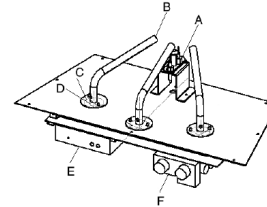

- A. Pilot assembly
- B. Burner
- C. Fixation plate
- D. Injector
- E. Gas control
- F. Receiver

8.1.4 Pilot/thermocouple assembly

Remove the burner tray as described above.

Now you have access to all the pilot and thermocouple parts .

8.1.5 Gas control block

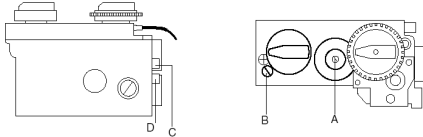

- A. Governor
- B. Adjusting screw pilot flame
- C. Working pressure

8.1.6 Combustion test

A BS7967 combustion analysis check should be carried out using an analyser to BS7927 positioned in the flue outlet, or draft diverter, or spillage test opening .

A Ratio of CO/CO2 should be less than 0.01 within 30 minutes (100 ppm CO per 1% CO2).

A reading of CO in the room centre should give a rise of less than 9 ppm over ambient, peak reading.

LIST OF SPARE PARTS

	Description	Timra	Vista
		Company Part	Company Part
1	Trim	208399xx	208400xx
	Glass frame	208403xx	208403XX
2	Glass	04510200	04510200
2.2	Glass ash tray	04510100	04510100
3	Burner NG	20900187	20900187
	Burner LPG	20900188	20900188
4	Log set	20793300	20793300
5	HT lead	06017301	06017301
6	Receiver	20604405	20604405
7	Remote control	20603900	20603900
8	Transformer	20900142	20900142
9	Gas control NG	37003089	37003089
	Gas control LPG	37003094	37003094
10	Motor Remote control	37003086	37003086
11	Pilot assembly NG	20900145	20900145
	Pilot assembly LPG	20900154	20900154
12	Thermo couple	37002033	37002033
13	electrode	06006600	06006600
14	Interrupter	37006027	37006027
15	Embers	20777300	20777300
16	spray for combustion chamber	09000008	09000008
17	spring ash pan cover door	27132300	27132300
18	TTB	37006055	37006055
19	TTB-lead front	06021900	06021900
20	TTB-lead back	06021800	06021800

TECHNICAL DATA

Country Cat.		UK/IRL I2H3+	UK/IRL I2H3+
		Timra/Vista	Timra/Vista
Appliance type		B11BS	B11BS
Reference gas		G20	G31
Input (nett)	[kW]	5	4,6
Efficiency class		2	2
Inlet pressure	[mbar]	20	37
Gas Rate (15° C en 1013 mbar)	m ³ /h	0,53	0,19
Setting pressure	[mbar]	12	20
Injector size	[mm]	3x1,2	3x0,8
reduced input restrictor	[mm]	1,6	1,0
Pilot assembly			
Type		SIT 160	SIT 160
code		Nr 51	Nr 30
Flue size (min)		100mm/125mm	100mm/125mm
Min Flue height		3 m	3 m
Gas control		GV36-CSA0EHC68M	GV36-CSA0DHC68M
Remote control			
adapter		230VAC/50HZ/5VA	230VAC/50HZ/5VA
Voltage adapter		4,5	4,5
Batteries remote control		2 x LR03 Alkaline long live	2 x LR03 Alkaline long live
Gas connection		8mm nut and olive	8mm nut and olive
Dimensions: see table 1			

USER GUIDE

9. SAFETY INSTRUCTIONS FOR THE USER

9.1 General safety instructions

If a gas leak is found or suspected, turn off the gas supply at the meter and contact your installer or gas emergency service.

These instructions should be read carefully and retained for future reference.

Do not use the fire with a broken or damaged glass.

The fire has a safety device which turns off the gas supply if there is a build up from flue gasses in the combustion room or a temporary gas cut-off. **Wait at least 5 minutes before turning the appliance on again.** Contact a qualified installer when the appliance goes off regularly

The appliance has been designed for heating purposes. This means that all surfaces, including the glass, can become very warm (over 100 °C). An exception to this is the lower side of the ash tray door and the control buttons.

Due to the newness of materials, they may give off a slight smell for a period after initial lighting. This is normal, odours will disperse after a few hours use.

Do not place curtains, clothing, laundry, furniture or other flammable materials nearby the appliance. The required minimum distance is 100 cm.

Switch off the receiver of the remote control if you don't use the fire for a long time. Do not let children use the remote control without supervision.

Important

A suitable Fireguard conforming to BS6539 and BS6778 should be used with this appliance to protect children, the elderly or infirm. Care should also be taken with pets.

In your own interest and that of safety, all gas appliances must be installed by competent persons. Installation must be in accordance with National Regulations. CORGI registered installers are required to work to recognised standards.

Note:

Since the appliance is a source of heat, circulation of air occurs. Therefore it is of importance that you do not use the appliance shortly after a renovation of the home. Because of the natural circulation of air, moist and volatile components from paint, building materials, carpet etc. will be attracted. These components can settle themselves down onto cold surfaces in the form of soot. As on all heat producing appliances, soft furnishings such as blown vinyl wallpaper placed too near to the appliance may become scorched or discoloured. This should be born in mind when installing the appliance.

We advise you to leave the pilot flame on. Leaving the pilot flame on reduces the amount of condensation when starting the appliance and increase the life time of the appliance.

10. CONTROLLING THE APPLIANCE

10.1 Lighting the fire

If the main burner or pilot light is extinguished for any reason, **do not attempt to relight the pilot within 5 minutes**. Contact a qualified installer when the appliance goes off regularly.

We advise you to leave the pilot flame on. Leaving the pilot flame on reduces the amount of condensation when starting the appliance and increase the life time of the appliance.

The control valve is behind the ash pan cover.



Open the ash pan **door** by pushing the small lip.

With control button A you can light the pilot. With the control button B you can adjust the height of the flames (see fig. below).

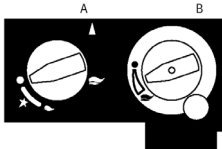

10.1 Lighting the fire (continuing)

Knob A

The ● is the OFF position preventing any gas from passing through the control valve to either the pilot burner or to the main burner. By pressing the knob in it is possible to turn it anticlockwise. The first function is to turn on the gas to the pilot- this occurs just before reaching the ✱ position (if the fire has not been lit for some time it may be necessary to hold the knob in this position for some seconds to clear the air from the pipe and allow gas to reach the pilot burner).

Once gas is available at the pilot, continued rotation anti-clockwise will cause the piezo igniter to spark. This is accompanied by a click at the valve and should result in the pilot burner igniting. Once the pilot is lit, the control knob should be held pressed in for 10 seconds. In this time the pilot flame will have heated the flame supervision thermocouple sufficiently to operate a hold-on magnet within the valve.

Now turn the control knob A to the ■ position. This allows gas to enter control knob B.

Knob B

The ● is the OFF position preventing gas entering the main burner if the pilot is lit. The knob should be turned slowly anticlockwise. This allows gas to enter the burner and be ignited by the pilot flame. Once ignition has taken place, the fire may be set to any level between min. and max. by adjusting the control knob B.

10.2 To light

1. Push in and turn the control knob (A) from ● anticlockwise to the setting ▲ (small flame). You will hear an ignition click. Check that the pilot is lit (if not repeat).
2. Continue to hold in the control knob for a further ten seconds to ensure that the pilot flame is stable.
3. Release the knob. The pilot should remain alight.
4. Turn the control knob A to the ▲ position.
5. Turn knob B slowly anticlockwise, the fire should then ignite.
6. Adjust flames to the required level.

10.3 To extinguish

1. For the main burner turn the control knob B clockwise to position ●.
2. To enable knob B turn knob A to the ▲ position.
3. To extinguish the pilot turn control knob A to position ●, although it is in order to leave the pilot permanently lit.

10.3.1 When the pilot extinguishes

Warning! When the pilot extinguishes, for whatever reason, you should wait at least 5 minutes before trying to turn it on again.

Possible causes of pilot extinguish are:

- Operating error.
- Interference of the safety device.
- Failure in the pilot flame system.

Contact a qualified installer when the appliance goes off regularly.

10.4 Remote control version

The remote control is only meant to regulate the flames from off till max., it functions only when the pilot burner is ignited and knob A in ▲ (big flame) position. It is therefore not possible to ignite the pilot flame with the remote control or to extinguish the pilot flame. The radio-frequency remote control is intended for fireplaces installed in a domestic setting in all EU countries, except Austria, Denmark, Finland and Greece.

Features:

- Manual control will always remain possible.
- The remote control is a radio frequency type and had been approved internationally.
- The remote control generates a unique safety code every time you activate the transmitter, it's similar to those used in a car.
- The remote control is easy to install retrospectively.

10.4.1 To light



1. Push in and turn the control knob (A) from ● anticlockwise to the setting  (small flame). You will hear an ignition click. Check that the pilot is lit (if not repeat).

2. Continue to hold in the control knob for a further ten seconds to ensure that the pilot flame is stable.

3. Release the knob. The pilot should remain alight.

4. Turn the control knob A to the  position.

5. Set the on/off switch on the receiver to "on".

 low flame

 high flame

6. Use  (high) and  (low) to achieve the desired heating and flame effect.

7. You will hear a beep every time the receiver recognises a good signal. (If not, so see 10.4.3, setting the right transmission code).

8. When the fire is not used for a prolonged period, turn off the remote control using the on/off switch on the receiver.

10.4.2 To extinguish

1. Push (low) till the burner goes out and you can hear the motor clicking.

2. To enable the remote control turn knob A to the  position.

3. To extinguish the pilot turn control knob A to position ● although it is in order to leave the pilot permanently lit.

10.4.3 Setting the right transmission code

The receiver has to learn the code from the transmitter, which is already done at the factory. However the code can disappear if the receiver is disconnected from the mains for a longer period.

1. Push the "mod" button on the receiver and hold it for 3 seconds.

2. The green control lamp will light up and stay on. Repeat this step if not.

3. Push a button on the remote control. The control lamp on the receiver should now go out.

4. Again push a button on the remote control. The lamp starts flashing and will switch off eventually.

5. The receiver now recognizes the remote control. The remote control now functions.

6. Check if you can hear a sound and the motor runs, when you push a button on the remote control. (If not so please check the batteries).

10.4.4 Changing the batteries

There is no risk of electric shock as the low voltage supply is similar to that used in torches. Always turn off the appliance before changing batteries.

10.4.4 Changing the batteries (continuing)

Remote control

1. Remove the cover on the back of the remote control.
2. Carefully remove the battery clip along the side. Pay attention not to pull the wires.
3. If necessary, remove the old batteries and place the new ones: 2 x LR03 Alkaline long life 1.5 V. Pay attention to the + and - position.
4. Click the battery clip into the remote control and close the cover.
5. It might be possible that you have to set the transmission code after changing the batteries (see 10.4.3).

Note

Batteries are chemical waste and should be disposed in accordance with local regulations.

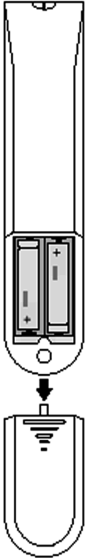

11. CLEANING AND SERVICE INSTRUCTIONS

Important:

Turn off the fire and allow it to cool down before commencing cleaning.

It is recommended that, the fire, is inspected/serviced, by a competent person at least once a year.

To maintain the finish on the trim wipe with soft damp cloth only. Do not use abrasive cleaners, polish or solvents as these can damage the surface finish.

12. DISPOSAL OF PACKAGING AND APPLIANCE

The appliance packaging is recyclable. The packaging could include the following materials:

- cardboard;
- CFC-free foam (soft);
- wood;
- plastic;
- paper.

These materials should be disposed responsibly and in conformity with government regulations.

Batteries are considered chemical waste. The batteries should be disposed of responsibly and in conformity with government regulations. Remove the batteries before disposing of the remote control.

Information on how to responsibly dispose of discarded appliances can be obtained from the local authorities.